



Programming User's Manual

2D Wireless Barcode Scanner

HW-855A



Restore default CCD module



Factory default for wireless module



Firmware CCD module version



Firmware wireless module version

Content

Wireless module settings	5
Introduction	5
LED Description.....	5
Buzzer Description	5
CCD module Default Settings.....	6
Wireless module Default Setting	6
Firmware Version CCD module.....	6
Firmware Version wireless module	6
Battery Display.....	6
USB cable Output Mode	7
If a USB cable is connected to the reader, data will only be sent via this port.....	7
Data Transfer Mode.....	7
Memory mode	8
USB Interface Type	9
Wireless Setting	9
Bluetooth HID transmission rate	10
IOS show/hide the Keyboard	10
Pairing Function	11
Sleeping Settings.....	11
Keyboard Language Settings.....	13
USB-HID Data type.....	16
UTF-8 chars Keyboard Conversion.....	16
GS (group separator) Control	17
Control Character Output for GS Control	17
GS (group separator) character conversion	17
Letter case conversion.....	18
Data Edit	18
Terminator character.....	18
Add Prefix and Suffix Settings.....	19
You can add characters to the front and back of the read data.	19
The syntax for adding is:	19
Finished Set for Data Edit	19
Hidden Character Settings	20
The syntax for hide is:.....	20
Finished Set for Data Edit	20
Scan Mode	21
Auto Sense Mode off	21
Auto Sense Mode on	21
Repeat Barcode Detection.....	21
Buzzer Configuration	22
Base Voice Setting.....	22
Prompt Tone Volume Setting	22
Prompt Tone Setting.....	22
Successfully Decode Prompt Tone Setting	23

Successfully Decode Prompt Audio Frequency Setting (Tone)	23
Successfully Decode Prompt Duration Setting	23
Error Warning Prompt Frequency Setting (Tone)	24
Code ID.....	25
AIM ID	25
Inverse color barcode selection.....	26
Barcode Type Selection	27
Enable/Disable All barcodes	27
Enable/Disable All 1D barcodes.....	27
Enable/Disable All 2D barcodes.....	27
Codabar.....	28
Codabar Start/Terminal Character	28
Set Length Range For Codabar	28
Code 39.....	29
Code 39 Parity Check	29
Code 39 Full ASCII	29
Set Length Range For Code 39.....	30
Code 32(Enable code39 first)	30
Code 32 Prefix.....	30
Interleaved 2 of 5 (ITF25)	31
Interleaved 2 of 5 (ITF25) Check Bit.....	31
Interleaved 2 of 5 (ITF25) Length Selection.....	31
Set Length Range for Interleaved 2 of 5	33
Industrial 2 of 5.....	33
Set Length Range for Industrial 2 of 5	33
Matrix 2 of 5 (4-24bit)	33
Set Length Range for Matrix 2 of 5.....	34
Code 93.....	34
Set Length Range for Code 93	34
Code 11.....	35
Code 11 Parity Check Output.....	35
Code 11 Parity Selection	35
Set Length Range for Code 11	36
Code 128.....	36
GS1-128.....	36
Set Length Range for CODE-128	37
UPC-A.....	37
UPC-A Check Bit	37
UPC-A Convert to EAN-13	37
UPC-E	38
UPC-E Check Bit	38
UPC-E Expand to UPC-A	38
EAN/JAN-8.....	39
EAN-8 Convert to EAN-13	39
EAN/JAN-13.....	39

UPC/EAN/JAN Add on code	39
EAN13 Convert to ISBN	40
EAN13 Convert to ISSN	40
GS1 DataBar (RSS14)	40
GS1 DataBar Limited	41
GS1 DataBar Expanded	41
PDF417	41
Micro PDF417	42
QR Code	42
QR Code URL Link.....	42
Micro QR	43
Data Matrix	43
Aztec Code	43
Appendix.....	44
Data Code Table.....	44
ASCII Code Table	45
Function and special keys	49
Ctrl, Alt, GUI keys	50
Table of numbers for barcode length range configuration	51
Barcode type ID Table.....	52
AIM ID Table	53
Visible Character ASCII Table	54
Invisible Character ASCII Table	55
Example for user-defined prefix and suffix:	56
Example 1.1:.....	56
Example 1.2:.....	56
Example for Hidden Character Settings.....	57
Example for barcode length range configuration.....	58
Example 2.1:.....	58
Example 2.2:.....	58
Example 2.3:.....	58
Read Skills	58
Safety	58

Wireless module settings





Introduction

Wireless barcode scanner transfers the data to computer via receiver.

If scanner & receiver need to re-pair, scan the "Pairing Function".

LED Description

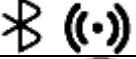
Indicator Description

Indicator Type		Details Description
Battery		Four bars, charging flash
Wireless status		Bluetooth/2.4G connection
Pairing		Bluetooth/2.4G quick flash
Scanner ring light		One flash for one successful scanning Slow flash for pairing mode
Base ring light		One flash for one successful data transferring Slow flash for pairing mode

Buzzer Description

Voice Type	Details Description
One medium long high voice	Successful pairing
One long and three short voice	Back from sleep
One short and long voice (Prompt, Successful)	Successfully reading code
Three continuous short voice	Alarm prompt

CCD module Default Settings

Scanning the below barcode can restore the CCD module scanner the default.



Restore default CCD module

Wireless module Default Setting



Default setting for wireless module

Scanning the below barcode can restore the wireless module scanner the default.

Firmware Version CCD module.



Firmware CCD module version

Firmware Version wireless module



Firmware wireless module version

Battery Display



Display battery capacity

Note: Percentage display

USB cable Output Mode

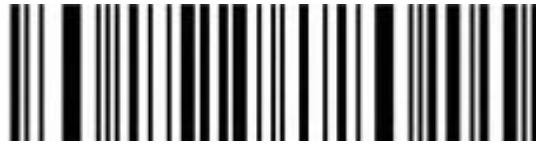

USB priority output (Default)

If a USB cable is connected to the reader, data will only be sent via this port.



Output simultaneously USB and wireless

Data Transfer Mode



Immediate (Default)



Automatic Storage

Note: Automatic storage mode. Data is automatically saved in scanner when exceed communication distance, scan the "Upload all data" code to complete the data transfer.



Memory

Note: Memory mode, the scanned barcode will be automatically saved in scanner. If the data need to be viewed or uploaded, then scan the "Upload all data" code to complete the data transfer.

Memory mode

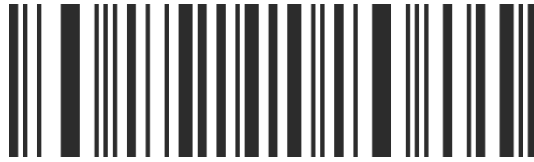

Upload all data



Clear all data

Note: Clear all data can be effective under Memory mode & Automatic Storage mode.



Display stored data

USB Interface Type



USB-HID (Default)



USB-COM

(For old OS Driver is needed for USB Virtual Com Port)

Wireless Setting



2.4 Ghz (Default)



Bluetooth HID Mode



Bluetooth SPP Mode

Note: Scan the Bluetooth code change to Bluetooth mode. When the scanner is restored, for Bluetooth mode scan the code again.

In Bluetooth SPP Mode recommended set Never Sleep.

Bluetooth HID transmission rate



Fast



Medium (Default)



Low

IOS show/hide the Keyboard

(Under Bluetooth mode)



Show or Hide

Pairing Function



2.4G Receiver Pairing

Note: Scan this code, scanner will enter the automatic pairing mode for 1 minute, then re-insert the receiver. There will be a sound heard when pairing successfully.

For Bluetooth pairing setting, search by Bluetooth device.



Bluetooth HID Pairing

Scan the “Bluetooth HID Pairing” barcode, the scanner is ready to be connected by other bluetooth devices.

Sleeping Settings

Different Sleeping time choices:



Never Sleep



10s



30s



1min



2min



5min (Default)



10min



30min



Immediate sleep – Sleep Now

Keyboard Language Settings



USA (Default)



Germany



France



Italy



Canada



Spain



Brazil



Sweden



Portugal



Belgium



Turkey-F



Turkey-Q



Poland



Finland



Latin America

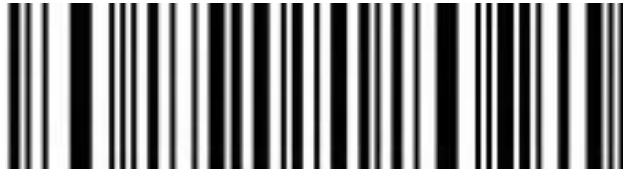

Serbia

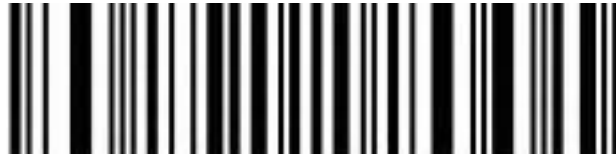

Hungary

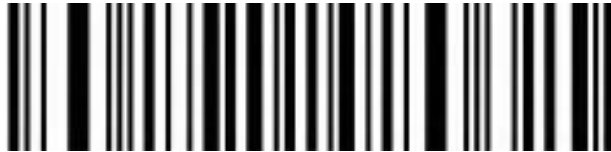

Denmark



Norway



Japan

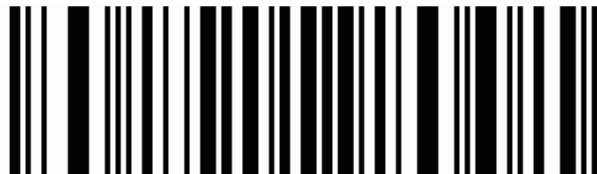

Czech

USB-HID Data type



Keyboard function key (Default)



ALT Mode ON -Universal language

ALT Mode must be set for send low ASCII chars like ETX, STX, LF ...

UTF-8 chars Keyboard Conversion

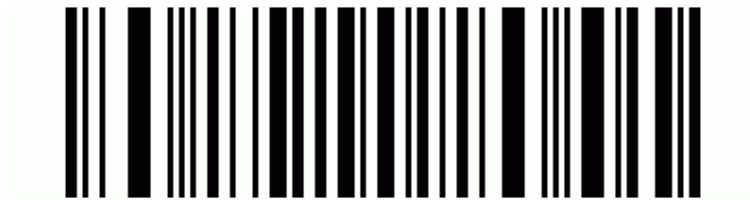

UTF-8 keyboards conversion

This feature works only in ALT mode.

GS (group separator) Control

Control Character Output for GS Control

This setting is for CCD module only, not for wireless module.



Disable (Default)



Enable

GS (group separator) character conversion



None (Default)

In ALT mode transfer GS like CTRL+] (terminal emulation keys).



GS convert to <GS>



GS convert to |



GS convert to]



GS convert to ^]

Letter case conversion



Normal Letter Case (Default)



All Uppercase



All Lowercase



Case Inversion

Data Edit

Data sending in this format [Prefix][CodeID][Data][Suffix][Terminator]

Terminator character



None



Enter (Default)



Tab

Add Prefix and Suffix Settings

You can add characters to the front and back of the read data.

The syntax for adding is:

1. Read settings code Add Prefix or Add Suffix



Add Prefix Setting



Add Suffix Setting

2. Choose the location from which you want the characters will be added. If you want to add from the first or last position, select 0 1. Perform by reading the appropriate codes corresponding to the numbers in the Appendix - Data Code Table. It is necessary to always read two numbers! The difference between a Prefix and a Suffix is in which side you count the characters from. Prefix - front / Suffix - back.
3. In the Appendix, find the appropriate codes (Tables ASCII Code Table, Function and special keys, Ctrl, Alt, GUI keys) for the characters or keystrokes you want to add. And you will gradually read them with a reader.
4. At the end save your settings, reading the code and Saved Finished Set.

Finished Set for Data Edit



Saved and Finished Set

If you want to clear the settings, follow steps 1 and 4 only.

Note: For a better explanation, look at the examples in the Appendix.

Hidden Character Settings

You can cut-hide characters in retrieved data. You can cut from the front or back.

The syntax for hide is:

1. Read settings code Hide front or Hide back character



Hide front character



Hide back character

2. Select the location from which you want to hide the characters. If you want to hide from the first or last position, select 0 1. Perform by reading the appropriate codes corresponding to the numbers in the Appendix - Data Code Table. It is necessary to always read two numbers!
The difference between a Hide front and a Hide back is in which side you count the characters from.
3. Now select how many characters you want to hide. Again, select two numbers from the table in the appendix, similar to point 2.
4. At the end save your settings, reading the code and Saved Finished Set.

Finished Set for Data Edit



Saved and Finished Set

If you want to clear the settings, follow steps 1 and 4 only.

Note: For a better explanation, look at the examples in the Appendix.

Scan Mode

Auto Sense Mode off

Decoding by pulling the trigger of the scanner when auto sense mode is off. It's default mode.



Off (Default)

Auto Sense Mode on

The scanner can sense barcode for decoding automatically.



On

Repeat Barcode Detection

Use for decode same barcode of interval time, it will decode only one time if not exceeded set time.



500ms



750ms (Default)



1s



2s

Buzzer Configuration

Base Voice Setting



Enable Base Voice (default)

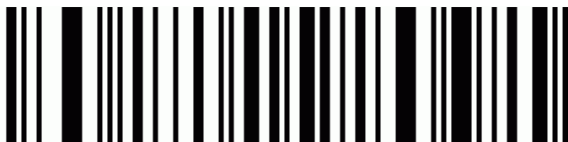

Disable Base Voice

Prompt Tone Volume Setting



Off



High (Default)



Medium



Low

Prompt Tone Setting



Sound frequency 2048Hz



Sound frequency 2700Hz

Successfully Decode Prompt Tone Setting



Off



On (Default)

Successfully Decode Prompt Audio Frequency Setting (Tone)



1 (Default)



2



3



Custom

Successfully Decode Prompt Duration Setting

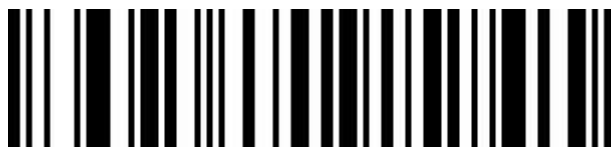

Long (Default)



Short

Error Warning Prompt Frequency Setting (Tone)

There will be four consecutive error warning tones if data transmission fails, and a single error warning tone when the unrecognized configuration code is scanned.



Low (Default)



Middle



High

Code ID

Please check Code ID from barcode type ID Table



Off (Default)



Before Switch on



After Switch On

AIM ID

Please check AIM ID from AIM ID Table



Off (Default)



Before Switch On



After Switch On

Inverse color barcode selection

(Only 1D/DataMatrix/Aztec)



Normal Color



Inverse Color



Both (Normal/Inverse)

Barcode Type Selection

Enable/Disable All barcodes

Enable all barcodes will low down decoding speed. So, we suggest you switch on scanner when needed.

(Default is switch on state)



Enable All



Disable All

Enable/Disable All 1D barcodes



Enable All



Disable All

Enable/Disable All 2D barcodes



Enable All



Disable All

Codabar



Enable



Disable

Codabar Start/Terminal Character



Not Send Codabar Start/Terminal Character (Default)



Send Codabar Start/Terminal Character

Set Length Range For Codabar



Minimum Length (0~50bit)



Maximum Length (0~50bit)

Code 39



Enable



Disable

Code 39 Parity Check

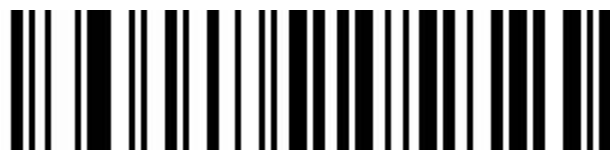

Disable (Default)



Enable But Not Transfer

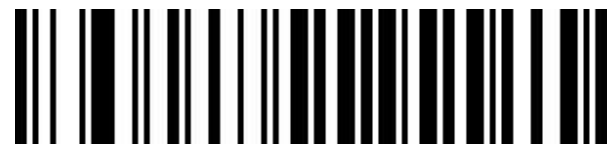

Enable & Transfer

Code 39 Full ASCII



Enable



Disable (Default)

Set Length Range For Code 39



Minimum Length (0~50bit)



Maximum (0~50bit)

Code 32(Enable code39 first)



Enable



Disable

Code 32 Prefix



Enable



Disable

Interleaved 2 of 5 (ITF25)



Enable



Disable

Interleaved 2 of 5 (ITF25) Check Bit



Disable Check Bit (Default)



Enable Check and Not Send Check Bit



Enable Check & Send Check Bit

Interleaved 2 of 5 (ITF25) Length Selection



Random Length (6-50bit) (Default)



6 Bit



8 Bit



10 Bit



12 Bit



14 Bit



16 Bit



18 Bit



20 Bit



22 Bit



24 Bit

Set Length Range for Interleaved 2 of 5



Minimum (0~50bit)



Maximum (0~50bit)

Industrial 2 of 5



Enable



Disable

Set Length Range for Industrial 2 of 5



Minimum (0~50bit)



Maximum (0~50bit)

Matrix 2 of 5 (4-24bit)



Enable



Disable

Set Length Range for Matrix 2 of 5



Minimum (0~50bit)

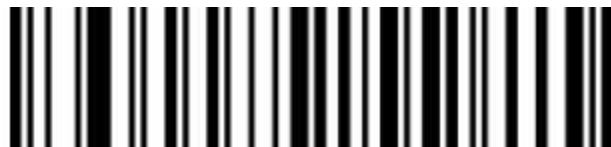

Maximum (0~50bit)

Code 93



Enable



Disable

Set Length Range for Code 93



Minimum (0~50bit)



Maximum (0~50bit)

Code 11



Enable



Disable (Default)

Code 11 Parity Check Output



Enable



Disable (Default)

Code 11 Parity Selection

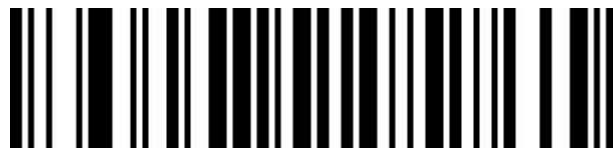

Disable (Default)



1 Bit



2 Bit

Set Length Range for Code 11

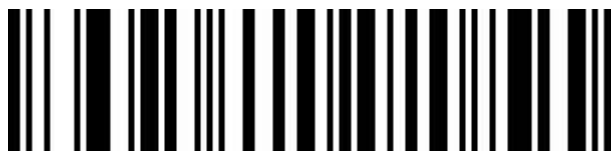

Minimum (0~50bit)



Maximum (0~50bit)

Code 128



Enable



Disable

GS1-128



Enable



Disable

Set Length Range for CODE-128



Minimum (0~50bit)



Maximum (0~50bit)

UPC-A



Enable



Disable

UPC-A Check Bit



Send UPC-A Check Bit (Default)



Not send UPC-A Check Bit

UPC-A Convert to EAN-13



Enable UPC-A convert to EAN-13



Disable UPC-A convert to EAN-13 (Default)

UPC-E



Enable



Disable

UPC-E Check Bit



Send UPC-E Check Bit (Default)



Not send UPC-E Check bit

UPC-E Expand to UPC-A



Enable



Disable (Default)

EAN/JAN-8



Enable



Disable

EAN-8 Convert to EAN-13



Disable EAN-8 convert to EAN-13



Enable EAN-8 convert to EAN-13

EAN/JAN-13



Enable



Disable

UPC/EAN/JAN Add on code



Ignore UPC/EAN/JAN (Default)



Decode UPC/EAN/JAN



Custom UPC/EAN/JANA add on code

EAN13 Convert to ISBN



Enable



Disable (Default)

EAN13 Convert to ISSN



Enable



Disable (Default)

GS1 DataBar (RSS14)



Enable



Disable

GS1 DataBar Limited



Enable



Disable

GS1 DataBar Expanded



Enable



Disable

PDF417



Enable



Disable

Micro PDF417



Enable



Disable

QR Code



Enable



Disable

QR Code URL Link



Disable



Enable

Micro QR



Enable



Disable

Data Matrix



Enable



Disable

Aztec Code













Enable



Disable

Appendix

Data Code Table































	 0	
 1		 2
	 3	
 4		 5
	 6	
 7		 8
	 9	







































































Saved and Finished Set



















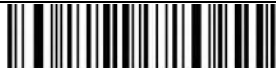







ASCII Code Table

Some special characters are conditioned by the keyboard emulation used. ALT-Mode vs. ASCII mode

























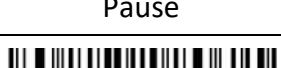

	 ^&400&^ SOH	
 ^&401&^ SOH (start of headline)	 ^&402&^ STX (start of text)	 ^&403&^ ETX
 ^&404&^ EOT	 ^&405&^ ENQ	 ^&406&^ ACK
 ^&407&^ BEL	 ^&408&^ BS	 ^&409&^ HT
 ^&40A&^ LF	 ^&40B&^ VT	 ^&40C&^ FF
 ^&40D&^ CR	 ^&40E&^ SO	 ^&40F&^ SI
 ^&410&^ DLE	 ^&411&^ DC1	 ^&412&^ DC2
 ^&413&^ DC3	 ^&414&^ DC4	 ^&415&^ NAK
 ^&416&^ SYN	 ^&417&^ ETB	 ^&418&^ CAN
 ^&419&^ EM	 ^&41A&^ SUB	 ^&41B&^ ESC
 ^&41C&^ FS	 ^&41D&^ GS	 ^&41E&^ RS

 ~&41F~ US	 ~&420~ SP	 ~&421~ !
 ~&422~ "	 ~&423~ #	 ~&424~ \$
 ~&425~ %	 ~&426~ &	 ~&427~ .
 ~&428~ ( ~&429~)	 ~&42A~ *
 ~&42B~ +	 ~&42C~ ,	 ~&42D~ -
 ~&42E~ .	 ~&42F~ /	 ~&430~ 0
 ~&431~ 1	 ~&432~ 2	 ~&433~ 3
 ~&434~ 4	 ~&435~ 5	 ~&436~ 6
 ~&437~ 7	 ~&438~ 8	 ~&439~ 9
 ~&43A~ :	 ~&43B~ ;	 ~&43C~ <
 ~&43D~ =	 ~&43E~ >	 ~&43F~ ?
 ~&440~ @	 ~&441~ A	 ~&442~ B

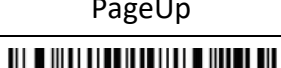
 ~&443&~ C	 ~&444&~ D	 ~&445&~ E
 ~&446&~ F	 ~&447&~ G	 ~&448&~ H
 ~&449&~ I	 ~&44A&~ J	 ~&44B&~ K
 ~&44C&~ L	 ~&44D&~ M	 ~&44E&~ N
 ~&44F&~ O	 ~&450&~ P	 ~&451&~ Q
 ~&452&~ R	 ~&453&~ S	 ~&454&~ T
 ~&455&~ U	 ~&456&~ V	 ~&457&~ W
 ~&458&~ X	 ~&459&~ Y	 ~&45A&~ Z
 ~&45B&~ [ ~&45C&~ \	 ~&45D&~]
 ~&45E&~ ^	 ~&45F&~ -	 ~&460&~ ,
 ~&461&~ a	 ~&462&~ b	 ~&463&~ c

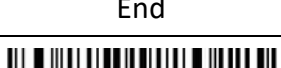
 ~&464&~ d	 ~&465&~ e	 ~&466&~ f
 ~&467&~ g	 ~&468&~ h	 ~&469&~ i
 ~&46A&~ j	 ~&46B&~ k	 ~&46C&~ l
 ~&46D&~ m	 ~&46E&~ n	 ~&46F&~ o
 ~&470&~ p	 ~&471&~ q	 ~&472&~ r
 ~&473&~ s	 ~&474&~ t	 ~&475&~ u
 ~&476&~ v	 ~&477&~ w	 ~&478&~ x
 ~&479&~ y	 ~&47A&~ z	 ~&47B&~ [
 ~&47C&~ 	 ~&47D&~]	 ~&47E&~ ~

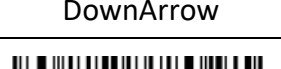
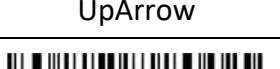
Function and special keys

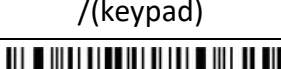
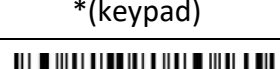
 ^&47F&^ DEL	 ^&480&^ Caps Lock	 ^&481&^ F1
 ^&482&^ F2	 ^&483&^ F3	 ^&484&^ F4
 ^&485&^ F5	 ^&486&^ F6	 ^&487&^ F7
 ^&488&^ F8	 ^&489&^ F9	 ^&48A&^ F10
 ^&48B&^ F11	 ^&48C&^ F12	 ^&48D&^ PrintScreen
 ^&48E&^ Scroll Lock	 ^&48F&^ Pause	 ^&490&^ Insert
 ^&491&^ Home	 ^&492&^ PageUp	 ^&493&^ Delete
 ^&494&^ PageDown	 ^&495&^ End	 ^&496&^ RightArrow
 ^&497&^ LeftArrow	 ^&498&^ DownArrow	 ^&499&^ UpArrow
 ^&49A&^ Num Lock(keypad)	 ^&49B&^ /(keypad)	 ^&49C&^ *(keypad)
 ^&49D&^ -(keypad)	 ^&49E&^ +(keypad)	 ^&49F&^ Enter(keypad)











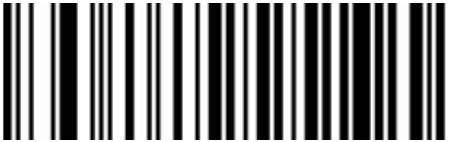
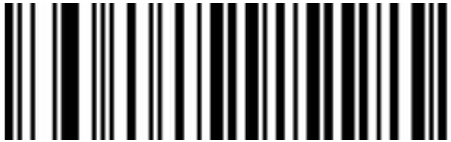



 `&4A0&` 1(keypad)	 `&4A1&` 2(keypad)	 `&4A2&` 3(keypad)
 `&4A3&` 4(keypad)	 `&4A4&` 5(keypad)	 `&4A5&` 6(keypad)
 `&4A6&` 7(keypad)	 `&4A7&` 8(keypad)	 `&4A8&` 9(keypad)
 `&4A9&` 0(keypad)	 `&4AA&` .(keypad)	

Ctrl, Alt, GUI keys

Note: There must always be a combination of pressing and releasing the function key. Otherwise, you will have problems with keyboard shortcuts, and your computer may be locked.

 `&4D0&` L-Ctrl Press	 `&4D1&` L-Shift Press	 `&4D2&` L-Alt Press
 `&4D3&` L-GUI Press	 `&4D4&` R-Ctrl Press	 `&4D5&` R-Shift Press
 `&4D6&` R-Alt Press	 `&4D7&` R-GUI Press	
 `&4D8&` L-Ctrl Release	 `&4D9&` L-Shift Release	 `&4DA&` L-Alt Release
 `&4DB&` L-GUI Release	 `&4DC&` R-Ctrl Release	 `&4DD&` R-Shift Release
 `&4DE&` R-Alt Release	 `&4DF&` R-GUI Release	

Table of numbers for barcode length range configuration

 0		 8
 1		 9
 2		 A
 3		 B
 4		 C
 5		 D
 6		 E
 7		 F



Save

Barcode type ID Table

Code type	HEX	CODE ID (Default)
All codes	99	
Codabar	61	a
Code128	6A	j
Code32	3C	<
Code93	69	i
Code39	62	b
Code11	48	H
EAN-13	64	d
EAN-8	64	d
GS1 DataBar	52	R
GS1-128 (EAN-128)	6A	j
2 of 5 Interleaved 2 of 5	65	e
Matrix 2 of 5	76	v
Industry 2 of 5/IATA	44	D
UPC-A	63	c
UPC-E	63	c
ISBN	42	B
ISSN	6E	n
MSI	6D	m
Aztec Code	7A	z
DataMatrix	75	u
PDF417	72	r
Micro PDF417	53	S
QR Code	51	Q
Micro QR Code	51	Q

AIM ID Table

Code type	AIM ID	Description
Codabar]Fm	m: 0~1
Code128]C0	m: 0, 1, 2, 4
Code32]A0	
Code93]G0	
Code39]Am	m: 0, 1, 3, 4, 5, 7
Code11]Hm	m: 0, 1, 3, 8, 9
EAN-13 / EAN-8]Em	m: 0, 1, 3, 4
GS1 DataBar]e0	
GS1-128 (EAN-128)]C1	
Interleaved 2 of 5]Im	m: 0, 1, 3
Matrix 2 of 5]X0	
Industry 2 of 5]S0	
UPC-A/ UPC-E]Em	m: 0, 3
ISBN]X0	
ISSN]X0	
Aztec Code]z0	
DataMatrix]dm	m: 0~6
PDF417 / Micro PDF417]Lm	m: 0~5
QR Code / Micro QR Code]Qm	m: 0~6

Visible Character ASCII Table

Dec	Hex	Char	Dec	Hex	Char	Dec	Hex	Char
32	20	<SPACE>	64	40	@	96	60	`
33	21	!	65	41	A	97	61	a
34	22	"	66	42	B	98	62	b
35	23	#	67	43	C	99	63	c
36	24	\$	68	44	D	100	64	d
37	25	%	69	45	E	101	65	e
38	26	&	70	46	F	102	66	f
39	27	'	71	47	G	103	67	g
40	28	(72	48	H	104	68	h
41	29)	73	49	I	105	69	i
42	2A	*	74	4A	J	106	6A	j
43	2B	+	75	4B	K	107	6B	k
44	2C	,	76	4C	L	108	6C	l
45	2D	-	77	4D	M	109	6D	m
46	2E	.	78	4E	N	110	6E	n
47	2F	/	79	4F	O	111	6F	o
48	30	0	80	50	P	112	70	p
49	31	1	81	51	Q	113	71	q
50	32	2	82	52	R	114	72	r
51	33	3	83	53	S	115	73	s
52	34	4	84	54	T	116	74	t
53	35	5	85	55	U	117	75	u
54	36	6	86	56	V	118	76	v
55	37	7	87	57	W	119	77	w
56	38	8	88	58	X	120	78	x
57	39	9	89	59	Y	121	79	y
58	3A	:	90	5A	Z	122	7A	z
59	3B	;	91	5B	[123	7B	{
60	3C	<	92	5C	\	124	7C	
61	3D	=	93	5D]	125	7D	}
62	3E	>	94	5E	^	126	7E	~
63	3F	?	95	5F	_			

Invisible Character ASCII Table

Decimal	Hexadecimal	Character
00	00	NUL
01	01	SOH
02	02	STX
03	03	ETX
04	04	EOT
05	05	ENQ
06	06	ACK
07	07	BEL
08	08	BS
09	09	HT
10	0A	LF
11	0B	VT
12	0C	FF
13	0D	CR
14	0E	SO
15	0F	SI
16	10	DLE
17	11	DC1
18	12	DC2
19	13	DC3
20	14	DC4
21	15	NAK
22	16	SYN
23	17	ETB
24	18	CAN
25	19	EM
26	1A	SUB
27	1B	ESC
28	1C	FS
29	1D	GS
30	1E	RS
31	1F	US

Example for user-defined prefix and suffix:

Example 1.1:

Set "XYZ" to the second position in the codes.

For example data in code is: 1234567890 - And it should look like this: 1XYZ234567890

1. Read code from Add Prefix



Add Prefix Setting

2. Add to the second position, select two number from Appendix - Data Code Table - reading the appropriate codes corresponding to the numbers -> 0 and 2.



0



2

3. In the Appendix, find the appropriate codes for chars X Y Z (Tables ASCII Code Table) to add. And you will gradually read them with a reader. X and Y and Z.



X



Y



Z

4. Save this settings reading code **Saved and Finished Set**.



Saved and Finished Set

Example 1.2:

Set two **Arrow Down** as last keystroke (remember that the last character is a terminator-CR).

1. Read code from Add Prefix



Add Suffix Setting

2. Add to the last position, select two number from Appendix - Data Code Table - reading the appropriate codes corresponding to the numbers-> **0** and **1**.



3. In the Appendix, find the appropriate codes for Arrows Down (Function and special keys Tables) to add. And you will gradually read them with a reader. **Arrows down .**



4. Save this settings reading code **Saved and Finished Set**.



Example for Hidden Character Settings

Hide two chars from second position.

For example data in code is: **1234567890** - And it should look like this: **14567890**

1. Read settings code Hide front character



2. Select second position select two number from Appendix - Data Code Table - reading the appropriate codes corresponding to the numbers -> **0** and **2**.



3. Now select how many characters you want to hide. Again, select two numbers from the table in the appendix, similar to point 2. -> **0** and **2**.



4. Save this settings reading code **Saved and Finished Set**.



Example for barcode length range configuration

Please sure it not bigger than current maximum length range when set up minimum length. Otherwise, it will show error. In the same way, must be make sure it's not smaller than current minimum length range when set up maximum length. Please for numbers and Save settings code only for Appendix ***Table of numbers for barcode length range configuration!!!***

Example 2.1:

Set Code 128 length range is 4-12bit

Step: Set "Code 128 Minimum (0~50bit)"; Set "4"; Set "Save"

Set "Code 128 Maximum (0+50bit)"; Set "1" "2"; Set "Save"

Example 2.2:

Set Interleaved 2 of 5 length is 14bit

It can set up by "ITF25 14bit", through barcode length range of Maximum /Minimum to set,too.

Step: Set "Interleave 2 of 5 Minimum (0~50bit)"; Set "1" "4"; Set "Save" Set "Interleave 2 of 5 Maximum (0+50bit)"; Set "1" "4"; Set "Save"

Example 2.3:

Set Code 39 length is random length

Step: Set "Code 39 Minimum (0~50bit)"; Set "0"; Set "Save"

Set "Code 39 Maximum (0+50bit)"; Set "0"; Set "Save"

Read Skills

To get a good reading performance, a beam of aim light from scanner should be aimed at the centre of barcode, support to aim in any directions for read convenient, too.

More nearby barcode, the beam of aim light is smaller; More further barcode, the beam of aim light bigger. For reading barcode correctly, if barcode small, the scanner should be close to barcode, if barcode big, the scanner should be farther to barcode.

If the barcode is highly reflective (for example: coated surface), please adjust the scanner angle to read it successfully.



Safety

Please not direct aim eye when the scanner has a strong ray of light, to avoid causing any hurt or unwell.